

SONY®



SRX-R320

4K Digital Cinema Projector

LMT-300

Media Block

STM-100

Theater Management System

sony.com/digitalcinema

The Next Generation of 4K Digital Cinema



Astonishing “4K” Visuals Powered by Sony’s Advanced Screen and Theater Management System

In 2007, Sony introduced an ultra-high-resolution projector system that incorporates an SRX-R220 4K SXRD projector and an LMT-200 Media Block, and adopts a unique self-contained enclosure design. Since its sensational debut, this projector system has rapidly acquired a huge reputation from a range of exhibitors worldwide due to its advanced features and functionalities specifically designed for digital cinema applications. To respond to the evolving demands of digital cinema exhibitors, Sony is proud to introduce another unique digital cinema projector system.

At the heart of this system are the SRX-R320 4K SXRD projector and LMT-300 Media Block. Its secure enclosure design allows the LMT-300 server to be seamlessly integrated into the chassis of the SRX-R320 projector, providing a high level of security that meets the SPB-2 anti-tamper regulation stipulated by the Digital Cinema Initiatives, LLC (DCI).

The SRX-R320 projector is equipped with three Silicon X-tal Reflective Display (SXRD™) devices, delivering an amazing resolution of 4096 x 2160 pixels (H x V) – more than four times the resolution of full HDTV (1920 x 1080), achieving a high contrast ratio of 2000:1. Thanks to selectable 4.2 kW, 3.0 kW, and 2.0 kW Xenon projector lamps and various optional lenses, the SRX-R320 allows for screen coverage of up to 22 meters (70 feet)* – providing a SMPTE-standard brightness level of 14 ft-L* on a wide screen.

The LMT-300 Media Block is a digital cinema server that incorporates hard disk drives (HDDs) with a large storage capacity of approximately 1TB and adopts a reliable RAID (Redundant Array of Inexpensive Disks) system. It can play back DCI DCP (Digital Cinema Package) files and allows the SRX-R320 projector to show digital cinema programs.

Another unique feature of the LMT-300 is its Screen Management System function, which is equipped as standard and can provide a variety of screen-management operations such as show scheduling, communication with other theater control systems like lighting and curtains, and setup and maintenance of the projector.

Moreover, this projector system offers the optional STM-100 Theater Management System software that allows theater staff to efficiently manage multiple auditoriums from a central PC connected to the theater LAN.

With extremely high resolution, outstanding security, and operational versatility, Sony’s digital cinema projector system based on the SRX-R320 4K projector is a perfect choice for digital cinema applications.

*14 ft-L is achieved on a 22-meter (70-foot) screen, when projecting CinemaScope® images by using the USHIO DXL-40SRXPRO 4.2 kW Xenon lamp and the LKRL-A001 Anamorphic Lens with Lens Changer Unit. The brightness level can be measured at the screen center with 100 IRE white and a screen gain of 1.8, when projecting the images through the projection booth window (portglass) with a transmittance of 93%. A ft-L (foot-lambert) is a unit of measurement for luminance. One foot-lambert equals 3.4262591 candelas per square meter.



Touch-panel display not included

System Advantages/Features

4K Resolution

Historically, the movie theater experience has always exceeded that achieved by home entertainment systems. The advent of HDTV (1920 horizontal pixels) and technical improvements in home theater equipment have stimulated the movie industry to think further ahead into the future. Meanwhile, the Hollywood movie studios have jointly agreed on standardizing 4K (4096 horizontal pixels) and 2K (2048 horizontal pixels) as the next-generation digital movie distribution and projection standards. Creating movies in 4K protects the future value of the content, and also provides a significant benefit to the theater audience. In recent years, stadium-type seating is becoming increasingly popular among modern cinema complexes. By sitting closer to the screen, the audience can enjoy a more immersive visual experience. However, those sitting in the front rows may witness pixel artifacts when the resolution provided by the projection system is not sufficient to fill the screen size. The SRX-R320 provides true 4K output, which reproduces the full detail of 4K content thanks to the 4K SXRD panels, 4K internal signal processing, and 4K-compatible optical system. Besides, since the SRX-R320 provides four times the resolution of 2K projectors, the visual quality of 2K and HD content is also improved over those provided by native 2K and HD-resolution projectors.

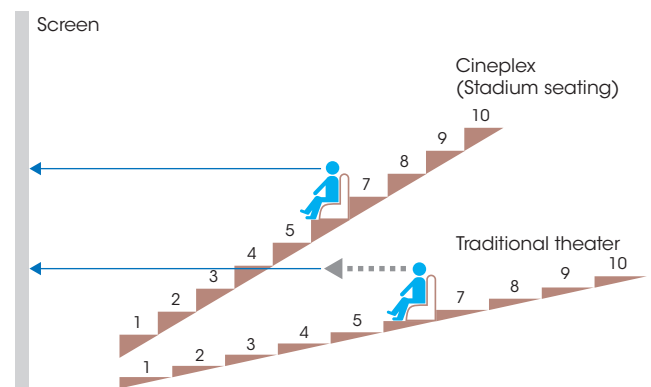

High 2000:1 Contrast Ratio

The SRX-R320 offers a high contrast ratio of more than 2000:1 through the use of Sony's unique SXR device. The SXR device itself achieves a contrast ratio of over 4000:1. This stunning picture quality makes the SRX-R320 ideal for applications in which dynamic range is essential. The high contrast ratio has been achieved through two key technologies – the 'normally black mode' system and an extremely thin liquid crystal cell gap.

Xenon Lamp Provides Highly Bright and Pure Light Source

The SRX-R320 provides a high brightness of 14 ft-L* on a wide screen using a Xenon lamp at full brightness. This high brightness can be achieved for a 20-meter (65-foot) wide screen when the SRX-R320 projects a full pixel size (4096 x 2160) image with a 4.2 kW Xenon lamp (USHIO DXL-40SRXPRO only) and the brightness level is measured at the screen center with 100 IRE white and a screen gain of 1.8. This brightness can also be achieved for a 17-meter (55-foot) or 14-meter (45-foot) wide screen when the SRX-R320 projects a full pixel size (4096 x 2160) image with a 3.0 kW or 2.0 kW Xenon lamp, respectively, and the brightness level is measured at the screen center with 100 IRE white and a screen gain of 1.2.

A Xenon lamp, standard in film projectors, provides pure, superb color tonal reproduction essential to meeting the stringent requirements of digital cinema. Xenon lamps, which are designed for the SRX-R320 and available from lamp manufacturers, satisfy the wide color range required for digital cinema by dispersion at a very flat and wide light spectrum.

* A ft-L (foot-lambert) is a unit of measurement for luminance. One foot-lambert equals 3.4262591 candelas per square meter.

** By lowering the brightness level of the projector lamp and attaching an appropriate ND filter to the projector lens, the SRX-R320 can be used for projection even on small screens. With this brightness adjustment, the SRX-R320 with a 2.0 kW lamp can be used for a 4.5-meter (15-foot) wide screen.

Table of Available Xenon Lamps

Sony-recommended Xenon lamps for the SRX-R320 are available from the following lamp manufacturers:

Lamp Manufacturer	Xenon Lamp		
	4.2 kW	3.0 kW	2.0 kW
USHIO INC.	DXL-40SRXPRO	DXL-30SRX	DXL-20SRX
OSRAM GmbH	XBO4200W/HRS OFR	XBO3000W/HPS OFR	XBO2000W/HPS OFR
PHILIPS	XDC-4200S	XDC-3000S	XDC-2000S

Variety of High-quality Lenses

Six optional zoom lenses are available for the SRX-R320. All lenses utilize very large image circles that contribute to minimizing the optical vignetting that typically occurs on projector lenses, and to obtaining the highest possible values of MTF (Modulation Transfer Function). With these features, the optical systems of the SRX-R320 have the capacity to reproduce resolutions higher than 4K, which is necessary to project 4K content exactly at 4K resolution. In addition, these lenses are designed to minimize chromatic aberrations using Sony's accumulated technical knowledge.



LKRL-Z111C



LKRL-Z114C



LKRL-Z116C



LKRL-Z117



LKRL-Z119



LKRL-Z122

Variety of Interfaces

The SRX-R320 supports a wide variety of signal formats including the 12-bit X'Y'Z' signal that is stipulated in the DCI specification. 10-bit 4:4:4 RGB and 10-bit 4:2:2 YpPr signal formats are also supported for playback of other alternative content.

- Two channels of SRLV, which are used for connection to the LMT-300 Media Block (for 4K projection: 4K DCP).
- A DVI (HDCP) interface that accepts DVI (HDCP) signals for up to 2048 x 1080 at 60 Hz (for 2K projection).
- A dual-link HD-SDI/DC-SDI input* that accepts any of the following signals:
 - For HD projection: SMPTE 372M dual-link HD-SDI (4:4:4), or SMPTE 292M HD-SDI (4:2:2)
 - For 2K projection: Dual-link DC-SDI (RGB 4:4:4), DC-SDI (YPbPr 4:2:2), or 12-bit X'Y'Z' signals (4:4:4)

* To support this input, the optional LKRI-003 board is required.

Resolution	Remarks
1 1024 x 768 at 60 Hz (XGA)	VESA
2 1280 x 960 at 60 Hz (SXGA1)	VESA
3 1280 x 1024 at 60 Hz (SXGA2)	VESA
4 1400 x 1050 at 60 Hz (SXGA+)	VESA
5 1600 x 1200 at 60 Hz (UXGA)	VESA
6 2048 x 1080 at 60 Hz (DC)	
7 1920 x 1080 at 24 Hz (HD)	
8 2048 x 1080 at 24 Hz (DC)	
9 1920 x 1200 at 59.95 Hz Reduced Blanking (WUXGA)	VESA
10 1920 x 1080 at 60 Hz (HD)	EIA/CEA-861B
11 2048 x 1080 at 48 Hz (DC)	

Operational Features

3D Dual Lens Adaptor

Attaching the 3D dual lens adaptor* to its lens mount, the SRX-R320 can deliver crisp 3D images** to screens up to 15 meters (50 feet)*** in width at 4.5 ft-L brightness. It allows full 2K resolution for the left and right eye simultaneously, resulting in a high-brightness, high-quality stereoscopic cinema presentation that offers more faithful reproduction of motion in 3D.

* For detailed information on the 3D dual lens adaptors, please contact your nearest Sony office.

** To produce 3D images on a screen, 3D filters available from a 3D system integrator are required. For detailed information on the 3D filters, please contact your nearest Sony office.

*** Screens up to 15 meters (50 feet) wide are supported, when 3D images are presented in Side Masking mode. When they are presented in Top-bottom Masking mode, screens up to 12 meters (40 feet) wide are supported. For detailed information on supported screen sizes, please contact your nearest Sony office.



SRX-R320 with 3D Dual Lens Adaptor attached

Anamorphic Lens

When projecting digital cinema content created in the CinemaScope format (4096 x 1716 pixels), the SRX-R320 cannot use all of the 4096 x 2160 pixels available for the 4K SXRD device. To improve this inefficiency, the optional LKRL-A001 Anamorphic Lens with Lens Changer Unit * was developed. When CinemaScope images (4096 x 1716 pixels) are input, the SRX-R320 extends them in a longitudinal direction via the projector's image-processing function, which effectively uses all the pixels of the SXRD device. The LKRL-A001 attached** in front of the projector's lens extends

the images in a transverse direction, so that the aspect ratio of the images projected on a screen can be restored to its original 2.39:1. This can increase the brightness level of the images on the screen by approximately 20%, allowing for the projector to provide a high brightness of 14 ft-L on screens up to 22 meters (70 feet) wide***.

The LKRL-A001 includes a lens-changer function that can set the anamorphic lens not to be in use manually. This function allows for the SRX-R320 to accept digital cinema content created in the Flat format (3996 x 2160 pixels), without dismounting the LKRL-A001 unit from the projector.

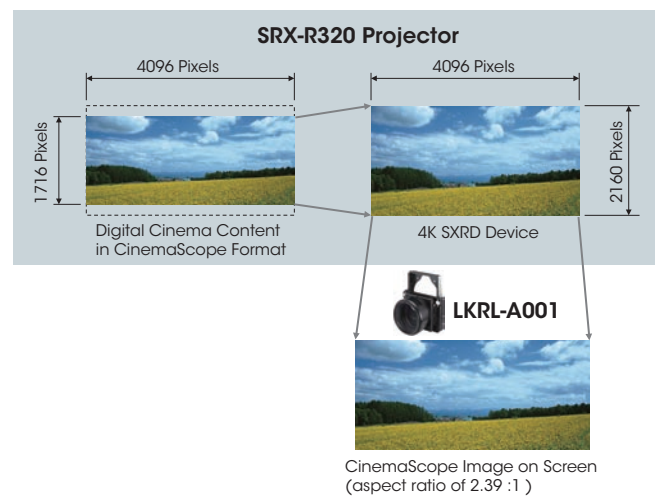

* The LKRL-A001 supports the LKRL-Z114C, LKRL-Z116C, LKRL-Z117, LKRL-Z119, and LKRL-Z122 optional lenses (the LKRL-Z111C is not supported), and throw ratios ranging from 1.7 to 4.03.

** To attach the LKRL-A001 to the projector, the following lens support stays are required. For detailed information, please contact your nearest Sony office.

*** The brightness level may vary depending on portglass and screen conditions.

Lens Support Stays

- A1675-703-A for the LKRL-Z114C
- A1675-704-A for the LKRL-Z116C
- A1675-705-A for the LKRL-Z119 and LKRL-Z122
- A1675-706-A for the LKRL-Z117



SRX-R320 with LKRL-A001 attached; Anamorphic lens not in use

Anamorphic Mode Function

The SRX-R320 allows squeezed images (16:9 or 1.896:1) to be changed to 2.39:1 un-squeezed images. This can be done electrically without an anamorphic lens.

Color Space Conversion (CSC) Function

The SRX-R320 features a Color Space Conversion (CSC) function, which helps users easily adjust the projector's color space to that which is defined in the DCDM (Minimum D-Cinema Color Gamut) or ITU-R BT.709. The target color gamut parameters required to meet the DCDM or ITU-R BT.709 standards can also be applied to the projector with this function. The internal test generator simplifies adjustment and lets the operator align the projector in minutes.

Gamma Curve Selection

The SRX-R320 provides three preset gamma curve values. Users can select an optimum value from 1.8, 2.2, and 2.6 according to the desired color tone.

Lens Shift Function

The SRX-R320 is equipped with a lens shift function that allows projected images to be moved up and down or from side to side. This lens shift function can be operated manually via the finger screws incorporated on the projector's unit. Using this function, the position of the projected images can be moved vertically by -50% to +50% and horizontally by -5% to +5%.

Keystone Masking

To compensate for keystone distortion, which typically occurs when the projector is not installed directly in front of the screen, the SRX-R320 has an image-masking function. To determine the best position for the masking, this function allows users to set further two points in addition to the four corner points, which is particularly useful when projecting onto a curved screen.

Select four corner positions to mask the area outside the perimeter.



For curved screens, select two positions at the apex of the curve, one at the top and one at the bottom of the screen.

Zoom/Focus Memory Function

The SRX-R320 is equipped with zoom and focus memory functions that make it easy to switch the projection between two types of aspect ratios.

When used with an optional zoom lens – such as the LKRL-Z111C, LKRL-Z114C, LKRL-Z116C, LKRL-Z117, LKRL-Z119, or LKRL-Z122 – the zoom and focus positions for the 1.85:1 screen format and 2.39:1 CinemaScope can be stored in the projector's memory and then instantly recalled from there. This allows for full-screen display regardless of the aspect ratio. An electronic vertical alignment feature is included in the same memory to compensate for vertical changes in the image, should the projector be mounted at a downwards angle.

Maintenance and Security Features

Easy Maintenance of Luminance Level

During long periods of usage, users commonly have to adjust the luminance level of their projector, as Xenon lamps typically get darker over time. The SRX-R320 has a convenient function to help users know when to make such adjustments. It allows users to set a standard luminance level, and displays an alert message on the LCD screen of the projector when the value changes from the standard level. With this feature, proper and timely maintenance of the luminance level can be performed.

Automatic Lamp Power Calibration Function

When switching the aspect ratio of projection from CinemaScope to VistaVision and vice versa, the luminance levels happen to change. To maintain a constant luminance level even after making these changes, the SRX-R320 can automatically calibrate the luminance level by controlling the lamp output power.

Air-flow Sensor for Reliable Cooling

The SRX-R320 has a chimney on top of the unit that expels warm air, thereby keeping the projector unit cool. The chimney has an air-flow sensor that measures the amount of discharged air. When the projector is powered on from Standby mode, the air-flow sensor operates automatically. If the value does not reach a normal level, an alert message is displayed on the projector's LCD screen. Thanks to this function, the operator can immediately take proactive maintenance action, allowing for reliable projector cooling.

Power Supply and Control of External Ventilation Fan

To efficiently discharge warm air from the unit, the chimney of the SRX-R320 projector must be connected to an exhaust duct with a ventilation fan. For optimum reliability and effectiveness, the projector supports an Interlock interface, which enables the SRX-R320 to operate this external ventilation fan. The projector can supply power to the fan and control its operation – the fan works when the projector is in Lamp ON mode or Standby ON mode.

Key Lock System

The SRX-R320 is designed to be highly secure. It does not have screw holes, and requires physical keys to open the enclosure. This body structure meets the SPB-2 anti-tamper requirement of the DCI. Even if the enclosure is opened with the physical keys, anti-tamper sensors will trigger the LMT-300 Media Block to immediately start recording logs for further safety. In this case, the projector also deletes Key Delivery Messages (KDM) automatically, so that DCP files cannot be played back.



SRX Controller Software

The SRX Controller software* is a convenient tool for system integrators to set up and maintain the SRX-R320. This runs on a PC** connected to the projector via the RS-232C interface, and features intuitive GUIs that enable easy setup and adjustment of the projector. A comprehensive range of setup parameters including input configurations, colorimetry controls, installation adjustments, and maintenance settings can be controlled via this software. For example, it allows operators to easily verify a lamp's operating time. Plus, the versatile projector functions such as Squeeze Mode, Color Space Conversion (CSC), and Zoom/Focus Memory can also be controlled via this software.

* For detailed information on availability of the SRX Controller software, please contact your nearest Sony office.

** System requirements for the SRX Controller software: Microsoft® Windows® XP Professional. Supported OS languages are English and Japanese only.

In addition to its extreme resolution and high contrast, the SXRD device used in the SRX-R320 projector has the following remarkable technological features:

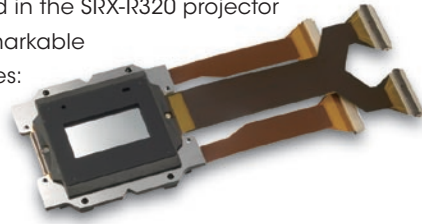

'Normally Black Mode' System

In every type of projector system, displaying absolute black is a major issue – as this helps to achieve a high contrast ratio. In other words, the contrast ratio of a projector depends on how effectively the light from the source can be blocked, so it does not leak through the display device. All Liquid Crystal Display (LCD) devices control the amount of light to be projected by applying an electric field to the liquid crystal gap. In typical LCD devices, black is produced when an electric field is applied across the liquid crystal cell gap. However, molecules near the surface of the glass substrate may not be accurately controlled due to the influence of the alignment film. This is not an issue for bright images but, when displaying dark images, light may tend to leak from the LCD device, since the molecules near the surface are less accurately controlled. This results in a creamy black instead of a deep black.

The SXRD device does not exhibit these characteristics. This is because the 'normally black mode' system displays black when the electric field is not applied and, because all molecules are in the correct alignment, the polarized light alignment is also optimized. The direct result is a far deeper black level, leading to a high contrast ratio.

Thin Liquid Crystal Cell Gap

Another important factor allowing for the high contrast of the SRX-R320 is the SXRD device's ultra-thin cell gap of less than 2 micrometers. With conventional 'vertically

aligned liquid crystal' systems, a thin cell gap could not be achieved. Sony has overcome this difficulty through the use of innovative planarization technology in the silicon backplane structure and an advanced silicon wafer-based assembly process.

The SXRD device also adopts a structure that does not use 'spacers'. These are columns found in conventional reflective liquid crystal devices to maintain a constant gap between the liquid cell floor and the top of the device. Spacers tend to both scatter and reflect light, which can impair high-contrast pictures. In the spacer-less SXRD device, these artifacts are no longer seen.

Short Response Time

The thin cell gap structure in SXRD devices also contributes to an ultra-fast response time of 2.5 milliseconds (for both rise and fall). The SXRD device reacts promptly to an instantaneous change of picture content, enabling SXRD-based projectors to display smooth motion. Consequently, the SRX-R320 virtually eliminates motion blur; a particularly significant benefit when presenting content that includes fast-moving objects.

Reliable Display Device

The SRX-R320 uses bright and highly powerful lamps. As a result, special attention has been paid to the reliability of the SXRD device. The inorganic materials utilized for the alignment layer of the SXRD device are resistant to deterioration or deformities that could occur due to the intense heat and light generated by the powerful lamp system.

12-bit SXRD Driver

The SRX-R320 utilizes a 12-bit display panel driver for reproducing extremely natural images.

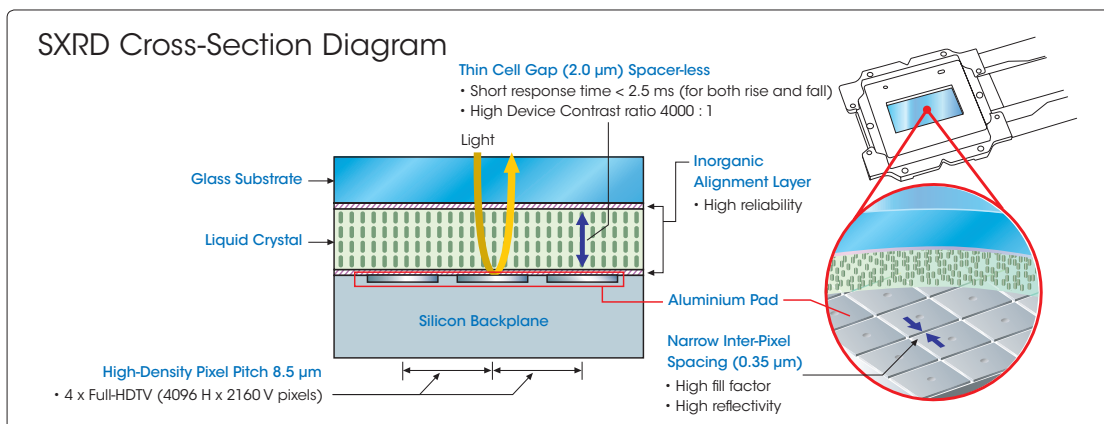

Digital Cinema Server – LMT-300 Media Block

The LMT-300 Media Block is a digital cinema server with a large storage capacity and high reliability. It can be seamlessly integrated into the chassis of the SRX-R320 projector, allowing for a highly secure digital cinema projector system. The LMT-300 can handle DCI DCP (Digital Cinema Package) files that consist of picture, audio, and subtitle data files, and that are wrapped into an MXF (Material eXchange Format) file. It can play back the DCP file by using advanced processing to decrypt and decode the picture data, and then send it to the projector over a secure multi-pin connection system.

Moreover, the LMT-300 incorporates the Screen Management System (SMS) function, which lets operators manage all of the devices necessary for digital cinema presentation from one location.

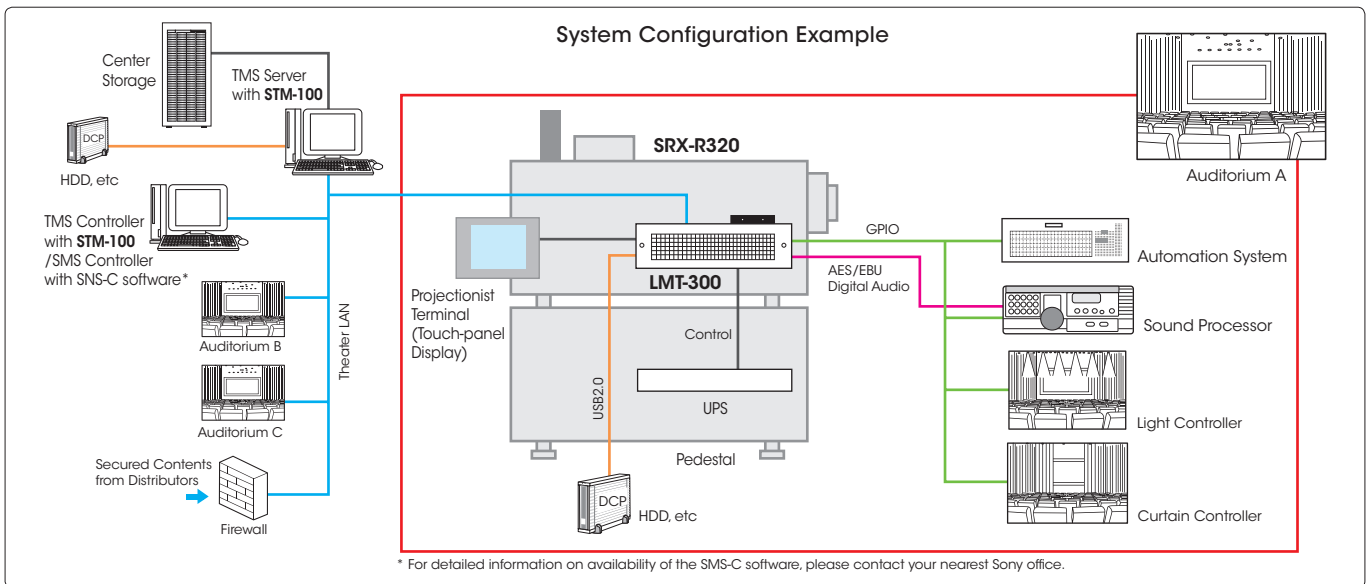
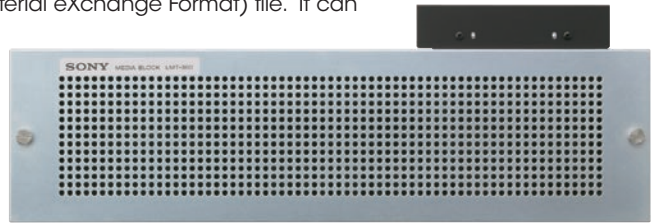

Large Storage Capacity and Reliable RAID System

The LMT-300 incorporates HDDs with a large storage capacity of approximately 1TB. It employs a RAID (Redundant Array of Inexpensive Disks) system that allows for highly reliable digital cinema presentation.

Decryption and Unwrapping of DCP Files

The LMT-300 can decrypt DCP files that have been encrypted using the AES (Advanced Encryption Standard PSP 197). It can also unwrap individual picture, audio, and subtitle data files for processing that are encoded within the MXF file.

Picture and Subtitle

The LMT-300 can decode JPEG 2000 picture data in real time for playback, regardless of whether the file was encoded at 2K or 4K resolution. Subtitles in Timed-Text/XML or PNG/XML format can be overlaid onto picture data before it is sent to the projector.

Audio

The LMT-300 transcodes audio DCP files into AES/EBU digital audio signals, and then outputs them from two audio output connectors (D-sub 25-pin) to external audio processors such as Dolby® sound processors. The audio output 1 and audio output 2 can support up to 8 and 16 channels, respectively. The timing of the audio output can be adjusted for complete synchronization with the picture, and any channel can be routed to any output to simplify installation.

Event Log Creation

The LMT-300 can generate event logs to record certain information – such as the number of times a movie has been played – which is a DCI requirement for secure content control.

Ingest of DCP Files During Playback

DCP files can be ingested to the LMT-300, even while playing a movie.

Screen Management System

As standard, the LMT-300 incorporates the Screen Management System (SMS), which is equivalent to the LSM-100 software designed for the SRX-R220/LMT-200 digital cinema projector system. Thanks to this SMS function, the operator can perform a variety of functions required for digital cinema presentation via the touch-panel screen of a projectionist terminal attached to the projector. This SMS function can also be operated remotely from a PC* connected to the theater network. In addition, the SMS can be seamlessly integrated with other theater systems that have the optional STM-100 Theater Management System software installed, as well as third-party auditorium automation systems.

The SMS of the LMT-300 satisfies the requirements of the DCI specifications version 1.2 for screen management and security.

*To support the SMS controller functions, the SMS controller software must be installed on the PC. For detailed information on its availability, please contact your nearest Sony office.

Screen Management Functions Operated by a Projectionist Terminal:

- DCP ingest/registration and DCP management
- Key Delivery Message (KDM) registration and key management
- Show Play List (SPL) creation and management
- Show schedule viewing
- Playback control
- Execution of SPLs
- Device configuration
- Device monitoring
- Status monitoring: collect status information from the projector and Media Block; report status at pre-configured intervals
- Monitoring of cavity security status from Media Block
- Automation system interface
- Projector Power On/Standby control
- Lamp Power On/Off control
- Adjustment of lamp power values
- Adjustment of the lamp bulb's z-axis
- Lamp serial code input function when installing a new lamp bulb
- Adjustment of a registration gap
- Display of filter information and reset timer
- Initialization of Cavity Security System (CSS)
- Content information display: title, aspect ratio, and KDM validity

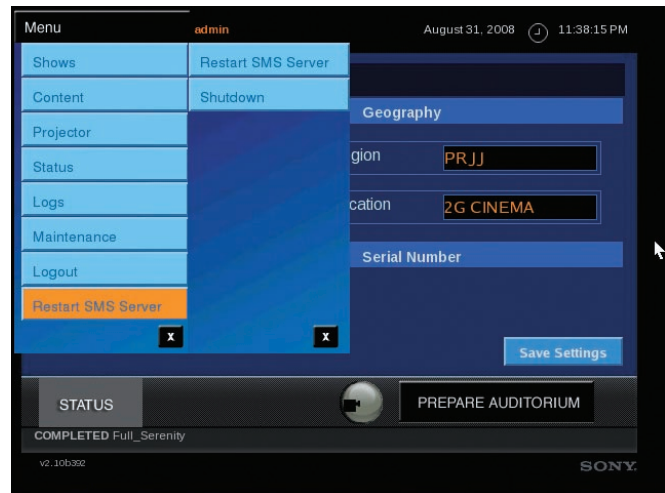

Menu window of projectionist terminal (touch-panel display)

Setup and Maintenance Functions by an SMS Control PC:

- Auditorium setup
- Log retrieval: including log filtering and secondary log distribution
- Interface (XML/HTTPS) to external Theater Management System (TMS)
- Automation system interface
- Security functions

Enclosure Status Light Management Functions:

- Monitors and aggregates status of all system components
- Sends aggregated status information to the status light of the enclosure

Theater Management System – STM-100



Menu window of STM-100

The STM-100 Theater Management System (TMS) is an optional software application that can provide efficient centralized management for cinema complexes featuring multiple auditoriums. The STM-100 provides a variety of the following functions:

Centralized Monitoring of Auditoriums Functions:

- Monitoring of auditorium and projector status
- Emergency operation of show (Stop, Pause, Resume, Resume with latency time)
- Display of auditorium details (Projector status, DCP ingest schedule, Show details, Error/Warning)
- Indication of status information such as fatal error/warning and creation/exporting of error logs

Schedule Management Functions:

- Daily and weekly schedule view with zoom function
- Import of schedule data from POS/Ticket system
- Easy schedule creation by drag-and-drop operation
- Automatic creation of To-do List with priority (unassigned SPL, lack of DCP/KDM, etc) for schedule making

Creation of SPL Functions:

- Show Play List (SPL) creation and management
- Composition Play List (CPL) grouping functions to combine multiple compositions (content programs such as trailers)
- Customized SPL template with Cue (output trigger)
- Blank time insertion into SPL
- Automatically adjustable cue setting
- Manual transfer of SPL to auditorium for test screening

DCP/KDM Management Functions:

- Centralized DCP/KDM management and status monitoring
- Display of hierarchical DCP/KDM list with automatic linkage
- Display of urgent level for necessary DCP/KDM ingestion to local storage
- KDM validity status indication
- Display of capacity of central storage and local storage
- Automatic and manual ingest of DCP/KDM to auditorium
- Automatic and manual deletion of DCP/KDM

Dimensions

SRX-R320

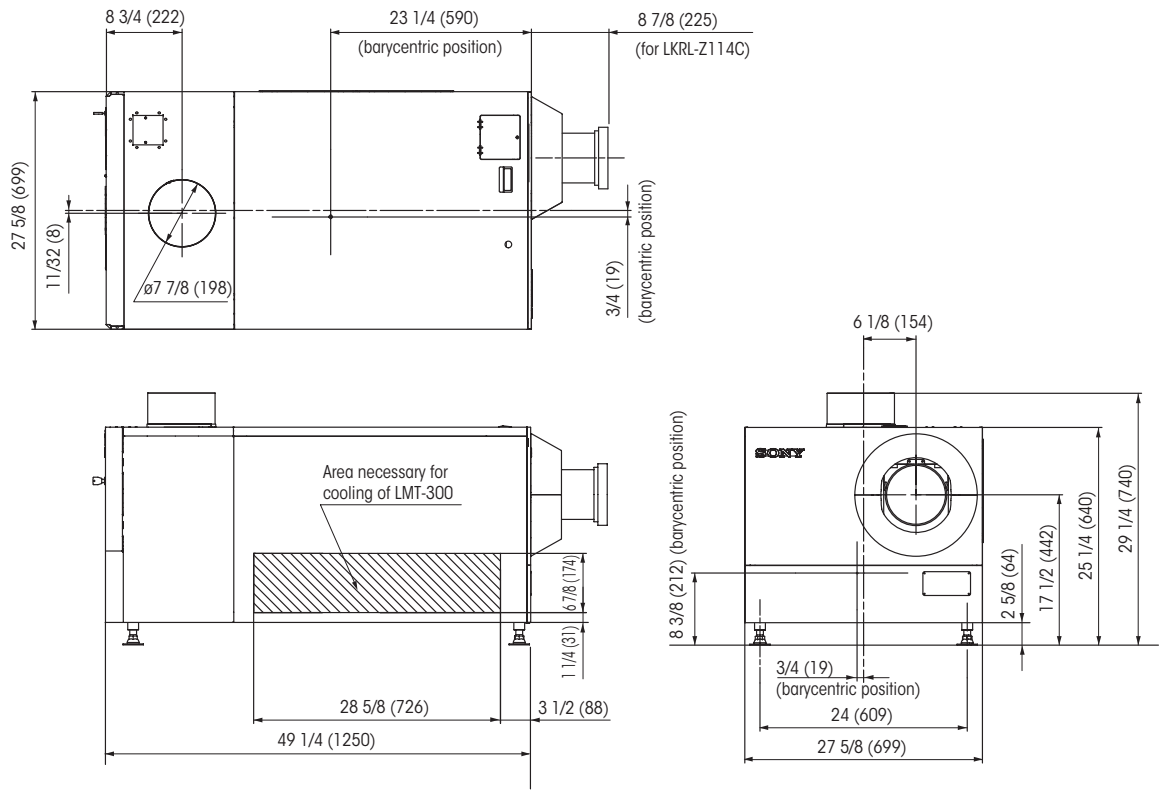

LMT-300

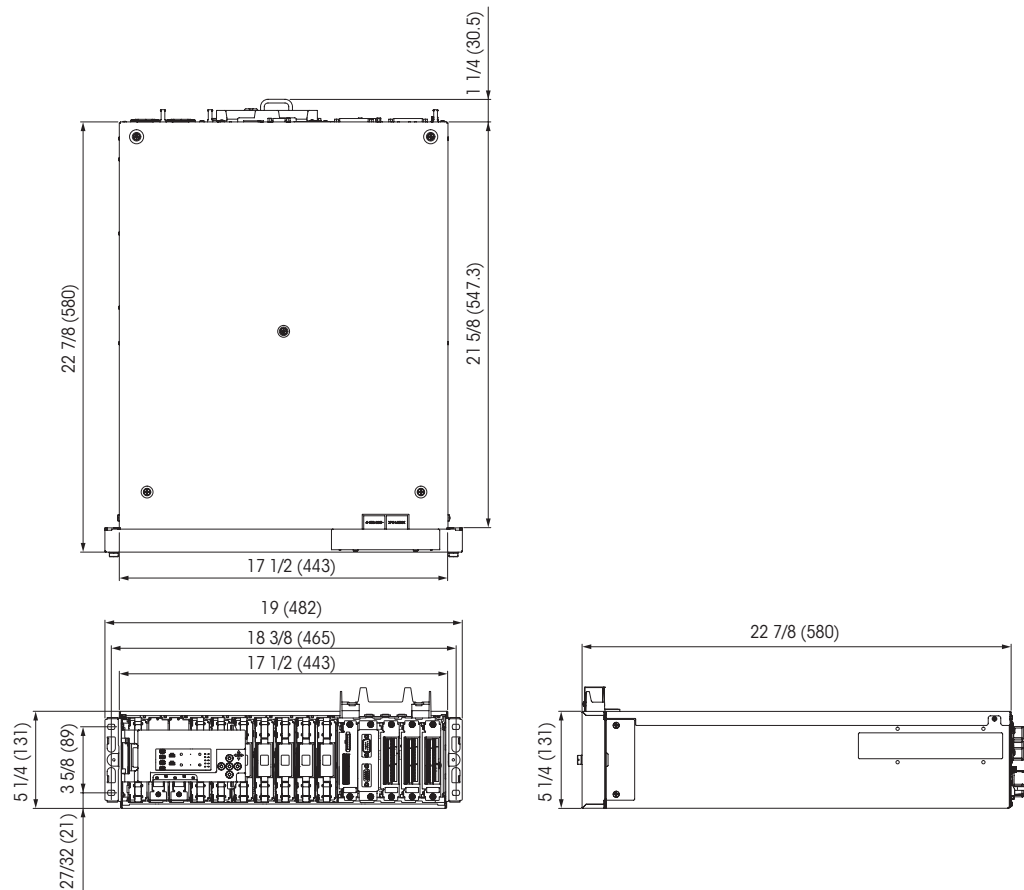

Unit: inches (mm)

Specifications of SRX-R320



General			
Colorimetry	Xenon color primaries		
	Encoding primaries	X	Y
	R	0.6800	0.3200
	G	0.2650	0.6900
	B	0.1500	0.0600
White reference	Xenon white reference		
	White reference	X	Y
		0.3140	0.3510
Contrast	Over 2000:1		
Input signal	Media Block input (x2): 4096 x 2160 pixels HD-SDI/Dual-link HD-SDI*: 1920 x 1080 pixels (SMPTE-372M/SMPTE-292M/ITU-R.B1709/BTA-S004) DC-SDI/Dual-link DC-SDI*: 2048 x 1080 pixels 12 bit/X'Y'Z' (with Dual-link HD/DC-SDI Input Board) DVI-D: XGA (1024 x 768), SXGA1 (1280 x 960), SXGA2 (1280 x 1024), SXGA+ (1400 x 1050), UXGA (1600 x 1200), WUXGA (1920 x 1200), HD (1920 x 1080), DC (2048 x 1080)		
Power consumption	Max. 5.4 kW (USHIO DXL-40SRXPRO 4.2 kW lamp)		
	Max. 4.2 kW (3.0 kW lamp)		
	Max. 3.0 kW (2.0 kW lamp)		
Power requirements	AC 200 V to 240 V, 50/60 Hz, single-phase, 27 A to 22.5 A		
Operating temperature	41 °F to 95 °F (5 °C to 35 °C)		
Operating humidity	35% to 85% (no condensation)		
Storage temperature	12 °F to 140 °F (-20 °C to +160 °C)		
Dimensions (W x H x D)	27 5/8 x 25 1/4 x 49 1/4 inches (700 x 640 x 1250 mm) (excluding a touch-panel display and projecting parts of the unit such as a status light and a chimney)		
Weight	429 lb (195 kg) (excluding an optional lamp and a lens)		

SXR Device Main Specifications	
Display device	SXRD (Silicon X-tal Reflective Display)
Size	1.55-inch (diagonal)
Resolution	4096 (H) X 2160 (V) Pixels
Reflectivity	77%
Contrast	More than 4000:1
Pixel pitch	8.5 μm
Width (between pixels)	0.35 μm
Response speed	2.5 ms (for both rise and fall)
Liquid crystal mode	Normally Black Mode
Alignment layer	Inorganic Thin Film
Backplane process	0.35 μm MOS Process
Liquid crystal cell gap	Less than 2 μm

Input/Output	
Input A	DVI-D (HDCP)
Input B	Open (option slot for the LKRI-003 or LKRI-005 board)
Input C	A channel
	B channel
	MDR- 68-pin (x1) (for projector output A of Media Block, SRLV connection)
	MDR- 68-pin (x1) (for projector output B of Media Block, SRLV connection)
Remote interface	D-sub 15-pin (female) (x1), RS-232C RJ-45 (x1), 10BASE-T/100BASE-TX Ethernet DCP ingest port (x1)
Interlock	D-sub 15-pin (female) (x1), RS-232C For supply of power to an external ventilation fan and control of its operation

Optical	
Projection system	3-SXRD panel, prism color integrated system
Imaging device	SXRD, 1.55-inch (diagonal), 4096 (H) x 2160 (V) pixels on each chip
Lamp	4.2 kW Xenon lamp (x1) or 3.0 kW Xenon lamp (x1) or 2.0 kW Xenon lamp (x1)
Screen coverage (approx.)	4.5-meter (15-foot) to 22-meter (70-foot) screen width on Scope size (USHIO DXL-40SRXPRO 4.2 kW lamp and LKRI-A001 anamorphic lens)
	4.5-meter (15-foot) to 17-meter (55-foot) screen width on Scope size (3.0 kW lamp)
	4.5-meter (15-foot) to 14-meter (45-foot) screen width on Scope size (2.0 kW lamp)
Light output	21000 lumens (average, USHIO DXL-40SRXPRO 4.2 kW lamp)
Color light output	21000 lumens (average, USHIO DXL-40SRXPRO 4.2 kW lamp)

Others	
Safety regulations	[UL60950 listed], [cUL60950], [FCC Class A], [IC Class A], [VCCI Class A], [EN60950], [CE Class A], [C-tick], [CISPR22], [CISPR24]
Supplied accessories	Lens cover (1 set), Keys for removing panels (2), Keys for lamp replacement panel (2), Lens attachment screws (M8) (4), Status indicator lamp (1), TPC adaptor (1 set), One-touch bush (1), Attachment screws for status indicator lamp and TPC adaptor (1 set), Duct for LMT-300 (A) (1), Duct for LMT-300 (B) (1), LVDS cables (2), CSS cable (1), Ethernet cable (1), Operating instructions (1)

* To support the HD-SDI/Dual-link HD-SDI or DC-SDI/Dual-link DC-SDI interfaces, the LKRI-003 Dual-link HD/DC-SDI Input Board is required. For information on using this board, please contact your nearest Sony office.

Specifications of LMT-300

General	
Power consumption	3.9A is needed for AC100V
Power requirements	1.7A is needed for AC240V
Operating temperature	5 °C to 35 °C (41 °F to 95 °F)
Operating humidity	35% to 85% (no condensation)
Storage temperature	-4 °F to 140 °F (-20 °C to +60 °C)
Dimensions (W x H x D)	17 1/2 x 5 1/4 x 22 7/8 inches (443 x 131 x 580 mm) (excluding projection parts)
Weight	55 lb (25 kg)
HDD	
Array composition	Data drive: 4 Parity drive: 2 Spare drive: 1
Record capacity	1 TB*, RAID 6
Video	
Projector output A	MDR 68-pin (x1) (for projector A channel, SRLV connection)
Projector output B	MDR 68-pin (x1) (for projector B channel, SRLV connection)
Compression format (decode)	JPEG 2000
Bit rate (J2K)	Max. 250 Mbps
Resolution	4096 (H) x 2160 (V), 2048 (H) x 1080 (V) pixels
Audio	
Audio output 1	D-sub 25-pin (female) (x2), unbalanced, 8 channels
Audio output 2	D-sub 25-pin (female) (x2), AES/EBU, 16 channels (Pin assignment for Dolby option board 790)
Digital audio format	24 bits, 48/96 kHz, Linear PCM
Interface	
Network	RJ-45 (x2), 1000BASE-T Ethernet (for data input) RJ-45 (x2), 1000BASE-T Ethernet (for control and spare)
CSS	HD D-sub 15-pin (female) (x1)
VGA	HD D-sub 15-pin (female) (x1) (for touch-panel controller)
UPS control	D-sub 9-pin (female) (x1)
Audio control	D-sub 9-pin (male) (x1)
GPIO	GPIO board (x3) (GPI: 1 to 8, GPO: 1 to 16)
Status light	Special 8-pin connector (x1) (for signals), special 10-pin connector (x1) (for power supply)

Subtitle	
Format	Timed-text/XML or PNG/XML
Security	
Decryption format	RSA 2048 bit, AES
Others	
Safety regulations	[UL60950 -1, CSA C22.2 No.60950.1], [FCC/IC EMC Class A Digital Device], [VCCI Class A], [EN60950-1], [EN50371], [EN55022/Class A], [EN55024 (ITE)], [EN61000-3-2], [61000-3-3], [IEC60950-1], [AS/NZS CISPR22 (EN55022) Class A], [JIS C 61000-3-2]
Supplied accessories	Plug holder (1), Screw (4), Terminal board (socket) 10-pin (1), Operating instructions (1), Installation manual (1)

* 1TB includes a capacity used for a system area where system information is recorded. The actual capacity available for recording data is 1 TB minus the capacity for the system area.

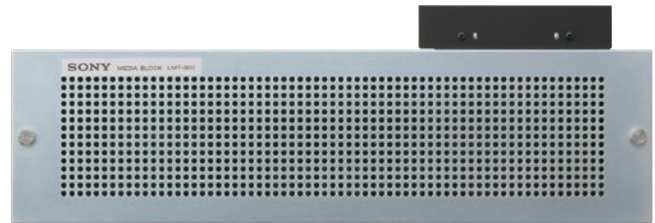

Front panel



Front view without front panel



Rear panel

Table of Available Lenses

		LKRL-Z111C	
Zoom Ratio		1.6x	
Throw ratio*		1.07:1 to 1.71:1	
F-number		2.8 to 2.9	
Screen width	Throwing Distance	Wide	Tele
	6,730 mm	7,099 mm	11,466 mm
	8,000 mm	8,465 mm	13,657 mm
	9,000 mm	9,541 mm	15,381 mm
	10,000 mm	10,617 mm	17,106 mm
	11,000 mm	11,694 mm	18,831 mm
	12,000 mm	12,770 mm	20,555 mm
	13,000 mm	13,846 mm	22,280 mm
	14,000 mm	14,922 mm	24,005 mm
	15,000 mm	15,998 mm	25,729 mm
	16,000 mm	17,074 mm	27,454 mm

		LKRL-Z114C		LKRL-Z116C		LKRL-Z117		LKRL-Z119		LKRL-Z122	
Zoom Ratio		1.5x		1.5x		1.4x		1.6x		1.8x	
Throw ratio*		1.35:1 to 1.98:1		1.50:1 to 2.29:1		1.72:1 to 2.39:1		1.81:1 to 2.94:1		2.23:1 to 4.03:1	
F-number		2.8		2.8		2.8		2.8		2.8	
Screen width	Throwing Distance	Wide	Tele	Wide	Tele	Wide	Tele	Wide	Tele	Wide	Tele
	4,500 mm	5,988 mm	8,865 mm	6,690 mm	10,289 mm	7,730 mm	10,862 mm	8,127 mm	13,365 mm	9,997 mm	18,150 mm
	5,000 mm	6,668 mm	9,864 mm	7,449 mm	11,448 mm	8,559 mm	12,041 mm	8,999 mm	14,823 mm	11,074 mm	20,137 mm
	6,000 mm	8,029 mm	11,863 mm	8,968 mm	13,765 mm	10,215 mm	14,400 mm	10,743 mm	17,738 mm	13,228 mm	24,109 mm
	7,000 mm	9,389 mm	13,862 mm	10,486 mm	16,082 mm	11,872 mm	16,759 mm	12,487 mm	20,654 mm	15,383 mm	28,081 mm
	8,000 mm	10,749 mm	15,861 mm	12,004 mm	18,399 mm	13,529 mm	19,118 mm	14,232 mm	23,570 mm	17,537 mm	32,054 mm
	9,000 mm	12,109 mm	17,859 mm	13,522 mm	20,716 mm	15,186 mm	21,477 mm	15,976 mm	26,486 mm	19,691 mm	36,026 mm
	10,000 mm	13,470 mm	19,858 mm	15,040 mm	23,033 mm	16,843 mm	23,836 mm	17,720 mm	29,402 mm	21,846 mm	39,998 mm
	12,000 mm	16,190 mm	23,856 mm	18,077 mm	27,667 mm	20,157 mm	28,553 mm	21,208 mm	35,233 mm	26,154 mm	47,943 mm
	14,000 mm	18,910 mm	27,853 mm	21,113 mm	32,301 mm	23,471 mm	33,271 mm	24,697 mm	41,065 mm	30,463 mm	55,888 mm
	16,000 mm	21,631 mm	31,851 mm	24,149 mm	36,935 mm	26,784 mm	37,989 mm	28,185 mm	46,896 mm	34,772 mm	63,833 mm

* Distance between the center of the projector lens and the screen, divided by the screen width.

Optional Accessories



LKRL-Z111C
Zoom Lens
Throw ratio*: 1.07:1 to 1.71:1

*The throw ratio denotes the ratio that the projection distance is divided by the screen width.



LKRL-Z114C
Zoom Lens
Throw ratio: 1.35:1 to 1.98:1



LKRL-Z116C
Zoom Lens
Throw ratio: 1.50:1 to 2.29:1



LKRL-Z117
Zoom Lens
Throw ratio: 1.72:1 to 2.39:1



LKRL-Z119
Zoom Lens
Throw ratio: 1.81:1 to 2.94:1



LKRL-Z122
Zoom Lens
Throw ratio: 2.23:1 to 4.03:1



LKRL-A001
Anamorphic Lens with
Lens Changer Unit

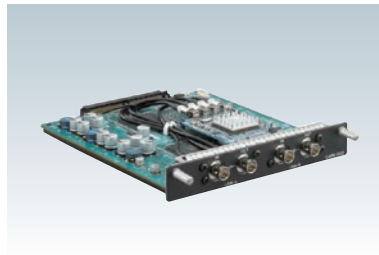

LKRI-003
Dual-link HD/DC-SDI Input Board

* For information on using the LKRI-003 board, please contact your nearest Sony office.

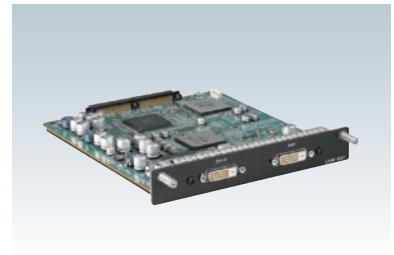

LKRI-005
DVI (HDCP) Input Board

* For information on using the LKRI-005 board, please contact your nearest Sony office.

SONY®

Sony Electronics Inc.
1 Sony Drive
Park Ridge, NJ 07656
sony.com/digitalcinema

DI-0189 (MK10626V1)

©2009 Sony Electronics Inc. All rights reserved.
Reproduction in whole or in part without permission is prohibited.
Features and specifications are subject to change without notice.

The values for mass and dimension are approximate.
Sony, SXR and their respective logos are trademarks of Sony.
Microsoft and Windows are registered trademarks of Microsoft Corporation.
VistaVision is a registered trademark of Paramount Pictures Corporation.

CinemaScope is a registered trademark of
20th Century Fox Film Corporation.

Dolby is a registered trademark of Dolby Laboratories.
All other trademarks are property of their respective owners.

The SRX-R320 and LMT-300 are produced
at Sony EMCS Corporation Kosal Tec, which
has received ISO14001 the Environmental
Management System certification.



Printed in USA (10/09)